

JVC

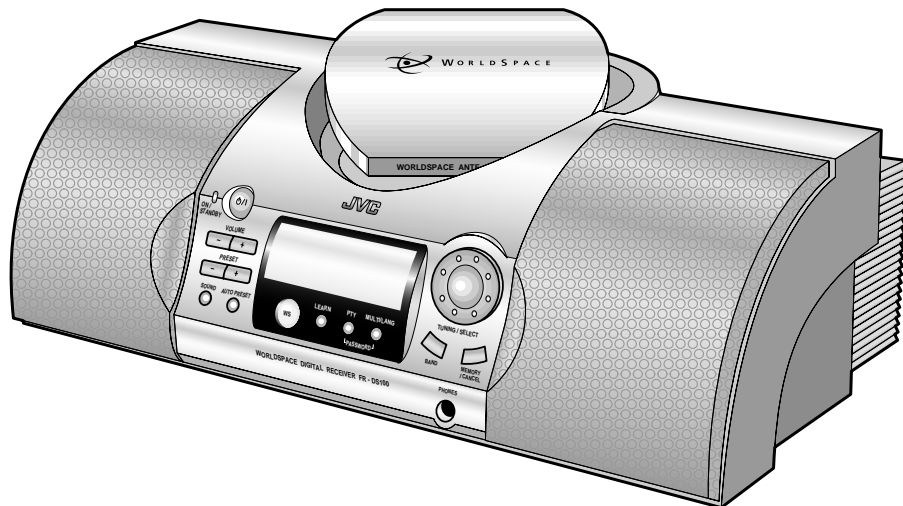

WORLDSPACE DIGITAL RECEIVER

FR-DS100



WORLDSPACE
CORPORATION

INSTRUCTIONS

For Customer Use:

Enter below the Model No. and Serial No. which are located either on the rear, bottom or side of the cabinet. Retain this information for future reference.

Model No. _____

Serial No. _____

ID No. _____

LVT0147-001A
[U]

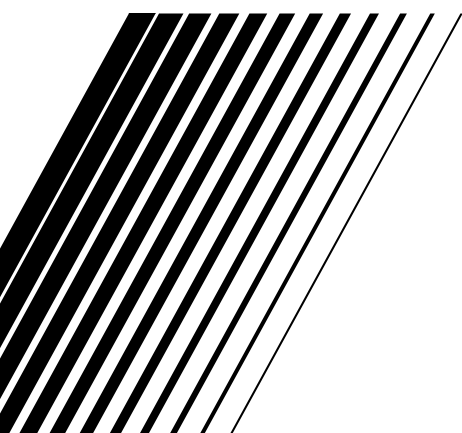

Warnings, Cautions and Others

Caution: ϕ /I switch!

Disconnect the mains plug to shut the power off completely. The ϕ /I switch in any position does not disconnect the mains line. The power can be remote controlled.

CAUTION

To reduce the risk of electrical shocks, fire, etc.:

1. Do not remove screws, covers or cabinet.
2. Do not expose this appliance to rain or moisture.

Caution: Proper ventilation

To avoid risk of electric shock and fire and to protect from damage, locate the apparatus as follows:

Front: No obstructions, open spacing

Sides: No obstructions within 10 cm from the sides

Top: No obstructions within 10 cm from the top

Back: No obstructions within 15 cm from the back

Bottom: No obstructions, level surface

In addition, maintain the best possible air circulation as illustrated below.

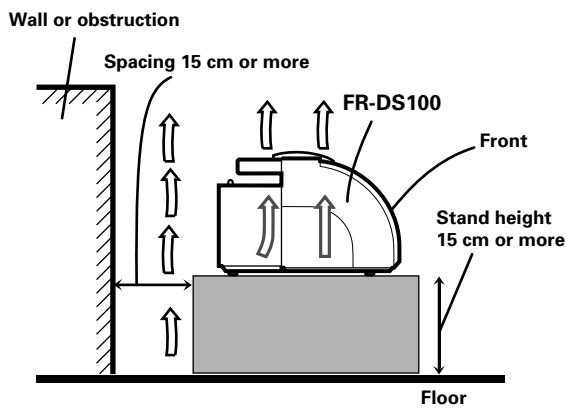

CONTENTS

Features	3
Safety Precautions	3
Handling Precautions	3
Unpacking	4
Power Supply	4
Connecting the WS antenna	5
Names of Parts and Their Functions	6
Front Panel	6
Rear Panel	7
Display Panel	8
Basic Operations	9
Setting up for WorldSpace reception	9
Listening to WorldSpace broadcasters	10
Listening to the radio (FM/AM (MW/SW))	11
Changing the audio presentation of the broadcast	11
Presetting WS broadcasters and radio stations	12
Clearing WS broadcaster presets	12
Preset Tuning	13
AC power resume function	13
Additional Operations	14
Searching for a preferred language	14
Searching for a program type (PTY)	15
Regarding encrypted broadcaster signals	16
Displaying the unit ID number	16
Recording a broadcast from the radio or WS band	16
Tuning the Time Division Multiplex (TDM) frequencies manually	17
Additional Information	18
WorldSpace™ Coverage Area	18
Troubleshooting	20
Specifications	20
WorldSpace™ Center Addresses	21

Regarding WorldSpace broadcast audio quality

Programs broadcast by WorldSpace utilize the newest technology in data compression (MPEG LAYER III) enabling audio ranging from telephone quality to that approaching CD quality. Audio quality of individual programs, however, depends on the broadcaster.

*WorldSpace™ is a registered trademark of
Worldspace corporation. All rights reserved*

Features

High quality digital sound

- Listen to near CD-quality broadcasts from all over the world when listening to the WorldSpace network band.

Detachable WorldSpace satellite antenna

- Freely position the antenna for optimal signal reception using the supplied WS specified extension cable.

Program and language search

- Easily find the type of program you want to listen to and the language you want to hear (subject to availability).

Digital synthesizer tuner

- Receive AM (MW/SW) and FM radio stations. Additionally, the AUTO PRESET function can be used to automatically create a list of presets for frequencies that can be received in your area.

LCD Display with back-light

- Read broadcaster information and display messages with ease. The back-light does not function when using batteries.

Safety Precautions

Prevention of Electric Shocks, Fire Hazards, and Damage

1. Even when the $\phi/1$ (STANDBY/ON) button is set to standby, a very small current will flow. To save power and for safety reasons, when not using the unit for an extended period of time, disconnect the power cord from the AC outlet.
2. Do not handle the power cord with wet hands.
3. When unplugging from the wall outlet, always grasp and pull the plug, not the power cord.
4. Consult your nearest dealer when damage, disconnection, or connect failure is found with the power cord.
5. Do not bend sharply, pull or twist the cord.
6. Do not modify the power cord in any manner.
7. To avoid accidents, do not remove screws to disassemble the unit and do not touch anything inside the unit.
8. Do not insert any metallic objects into the unit.
9. Unplug the power cord when there is a possibility of lightning.
10. If water gets inside the unit, unplug the power cord from the outlet and consult your dealer.
11. Do not block the ventilation holes of the unit so that heat can escape. Do not place the unit in a badly ventilated place.

$\phi/1$ (STANDBY/ON) button

When the power cord is connected to an AC outlet, the standby indicator is lit red, when the unit is in the standby mode (this indicator does not light when DC power is supplied). When the power is switched on, the indicator turns off showing that the power is on.

When this unit is plugged into an AC outlet, it consumes a small current to back up the memory of the microprocessor, even when the $\phi/1$ (STANDBY/ON) is set to standby.

PRECAUTIONS REGARDING WS ANTENNA SHORT-CIRCUIT

When there is a possible short-circuit in the WS antenna, the unit will exhibit the following.

1. The WS antenna reception indicator and WorldSpace band indicator will occasionally disappear.
2. When the WS band is selected, the WS band indicator and WS antenna reception indicator will blink.
3. After broadcaster reception is initiated, the sound will be muted for about two seconds before being received.

When these precautionary signs are noted, bring the unit to an authorized JVC dealer or service station.

Handling Precautions

1. **Avoid installing in the following places.**
 - Where it could be subject to vibrations.
 - Where it is excessively humid, such as in a bathroom.
 - Where it could be magnetized by a magnet or speaker.
2. **Do not place cassette tapes, etc. near the speakers.**

Since there are magnets in the speakers, do not place tapes or magnetic cards on them as recorded data could be erased.
3. **Keep this unit away from your TV.**

When this unit is used near a TV, the TV picture could be distorted. If this happens, move this unit away from the TV. If this does not correct the situation, avoid using this unit when the TV is turned on.
4. **Cleaning the cabinet**

If the cabinet gets dirty, wipe it with a soft dry cloth. Never use benzene or thinner as these could damage the surface finish.
5. **When listening with headphones**
 - Do not listen at high volumes as it could damage your hearing.
 - For safety, do not drive while listening to this unit on headphones.
6. **Carrying handle**
 - Do not raise or lower the carrying handle with the telescopic antenna extended, to avoid damaging the antenna. Place the carrying handle so that it does not interfere with operation.
 - After connecting the WS antenna cable, be sure to check that the cable is under and not over the carrying handle. If the cable is over the handle, using the handle to carry this unit may stretch the cable and cause the unit to malfunction.

Unpacking

Check that the following items were supplied with the FR-DS100.

- WorldSpace (WS) antenna (1)
- AC power cord (1)
- Plug adapter (1)
- WS specified extension cable (1)
- ID number sticker sheet (1) *

* The 16-digit ID number is not the serial number. The ID number is necessary when subscribing to WorldSpace broadcaster services. Using the ID number stickers, keep the ID number of your unit in safe locations where it can be easily found or referred to if necessary. (Refer to page 16.)

Power Supply

A. Operation on AC power

- When the FR-DS100 is used in an area where the supply voltage is different from the preset voltage, set the voltage selector to the correct position. For more information, refer to "To set the voltage selector" below.
- Insert the AC power cord firmly and completely into the AC IN jack on the unit.

CAUTIONS:

- ONLY USE WITH JVC POWER CORD PROVIDED WITH THIS UNIT TO AVOID MALFUNCTION OR DAMAGE TO THE UNIT. REMOVE BATTERIES WHEN USING THE POWER CORD.**
- BE SURE TO UNPLUG THE POWER CORD FROM THE OUTLET WHEN GOING OUT OR WHEN THE UNIT IS NOT IN USE FOR AN EXTENDED PERIOD OF TIME.**

To set the voltage selector

Before attempting to use this unit, check the voltage selector on the rear panel of this unit to determine if the selected voltage is appropriate for the power supply in your area. If you need to change the setting to match your local power supply, use a screwdriver to turn the arrow mark until it is pointed at the appropriate voltage setting.

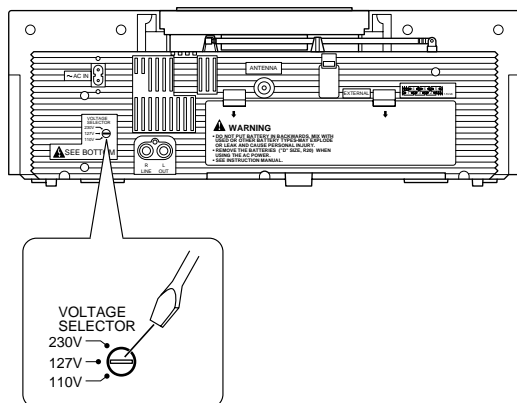

B. Operation on batteries

Loading batteries

- Open the battery cover by pulling it toward you while pressing down on the tabs marked by the arrows.
- Insert 6 "D" size/R 20 batteries as shown in the diagram below. A similar diagram can also be found on the rear panel of the unit.
 - * Be careful to insert the batteries with the ⊕ and ⊖ terminals oriented correctly.
- Replace the cover.

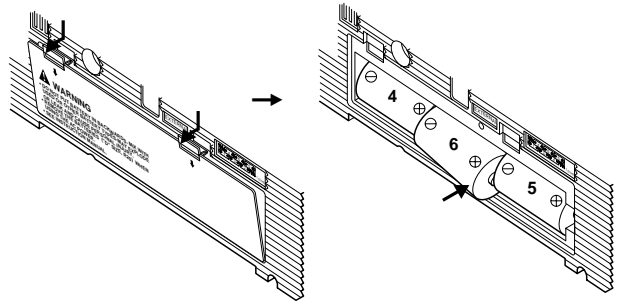

Removing batteries

- Open the battery cover as indicated above.
- Remove the center battery by hooking your finger onto the cusp of the ⊕ side of the battery, and pulling outward. The other batteries should then be easily removable.
- Repeat step 2 with the other row of batteries.

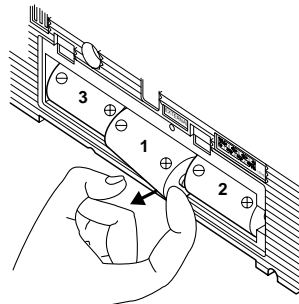

CAUTIONS WHEN USING BATTERIES:

When batteries are used incorrectly, it may result in the leakage of chemicals from the batteries or they may explode. If chemicals from the batteries come in contact with your skin, wash them off immediately with water. If chemicals leak onto the unit, clean the unit completely.

The following care should be taken;

- Check that the positive ⊕ and negative ⊖ terminals of the batteries are oriented correctly and load them as shown in the diagram.
- Do not mix old and new batteries together, or mix different types of batteries.
- Do not try to recharge non-rechargeable batteries.
- Remove the batteries when the unit is not to be used for an extended period of time.

Connecting the WS antenna

For safety reasons, make sure that the unit is not plugged in and batteries are not installed when making connections.

To install the WS antenna

1. To install the WS antenna, orient the antenna by lining up the arrow marks on the front of the WS antenna and on the front side of the housing platform. Slide the antenna into the housing platform at an angle so that the groove on the back side of the base of the antenna fits into the corresponding tab on this unit.

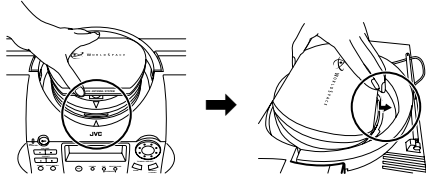

2. Push down on the front end of the base of the antenna until it clicks into place.

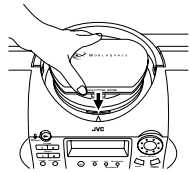

To connect the antenna cable

Connect the antenna cable to the antenna jack located on the rear panel of the unit.

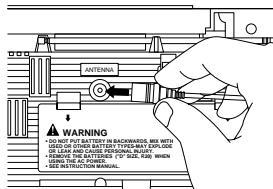

Notes:

- Be sure not to place the back of this unit against a wall or other surface when the antenna cable is connected as it may damage the cable and/or antenna jack.
- Be sure to check that the cable under and not over the handle of the unit. If the cable is over the handle, using the handle to carry this unit may be the cause of malfunction.

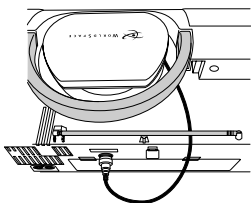

To remove the WS antenna from the housing platform

Pull up on the front end of the antenna unit to unlock the base. The WS antenna should then be easily removable.

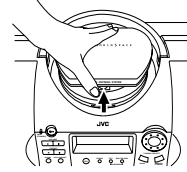

CAUTION:
DO NOT FORCE THE WS ANTENNA INTO OR OUT OF THE HOUSING PLATFORM. THIS MAY CAUSE DAMAGE TO THE WS ANTENNA AND CAUSE THIS UNIT TO PERFORM IMPROPERLY.

To connect the extension cable.

1. Disconnect the WS antenna from the antenna jack.
2. Connect the extension cable into the antenna jack on the rear panel of the unit.
3. Slide the rain protection cover on the extension cable back so that the connector protrudes.

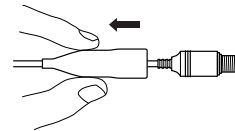

4. Firmly connect the extension cable with the WS antenna cable.

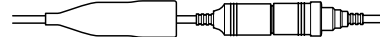

5. Slide the rain protection cover over the connected section completely for best performance.



CAUTION:

The rain protection cover is not intended to be left out in heavy rain or submerged in water. Please avoid exposing this section of the cable to excessive moisture.

Notes:

- To help ensure long-lasting performance of this unit, do not leave the extension cable and antenna outside or in direct sunlight for long periods of time. It is recommended that you restore the WS antenna to the housing platform when you are finished using the unit.
- The WS specified extension cable supplied with this unit is specially designed for use with this unit. Should you use a cable not supplied with this unit nor recommended by JVC for use with this unit, JVC cannot guarantee the performance of this unit. For details regarding compatibility with this unit, please consult with the manufacturer of the cable.

To adjust the WS antenna

For details on how to position the WS antenna for best possible reception, refer to page 9.

Names of Parts and Their Functions

Front Panel

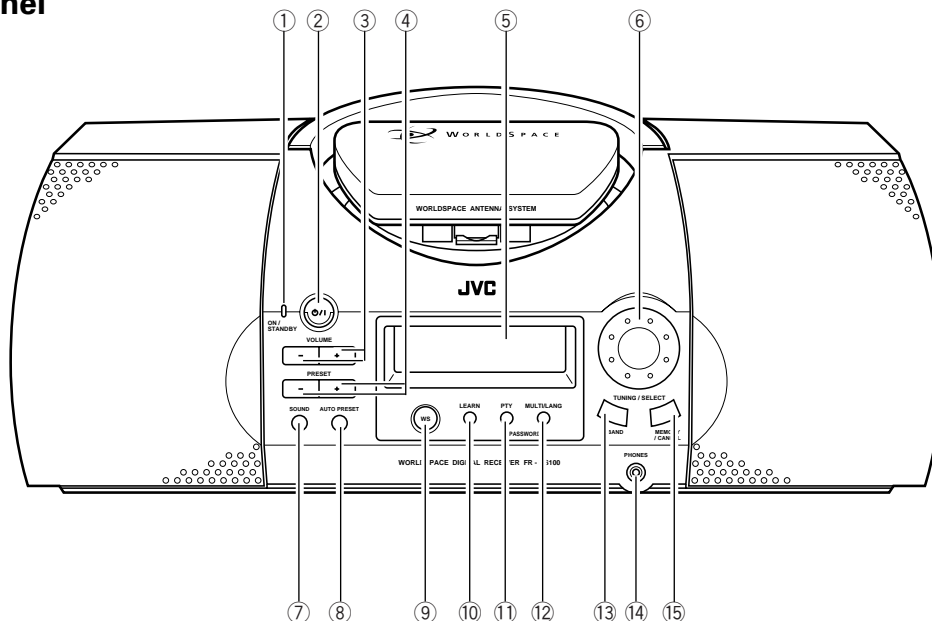

- ① **STANDBY indicator**
Lights red when the power is turned to standby (does not light when DC power is used).
- ② **ON/STANDBY button**
Press to turn the unit on or to turn to standby.
- ③ **VOLUME -/+ buttons**
Use to adjust the volume.
- ④ **PRESET -/+ buttons**
Use to select presets to be stored, recalled or cancelled.
- ⑤ **Display panel**
Displays radio, WS broadcaster, and other system information. Refer to page 8.
- ⑥ **TUNING/SELECT dial**
Use to tune radio frequencies and select WS band broadcasters.
- ⑦ **SOUND button**
Press to change the audio presentation of a broadcast.
- ⑧ **AUTO PRESET button**
Press to automatically preset available stations in your area within each band (except for WS band).
- ⑨ **WS button**
Press to receive the WS band.
- ⑩ **LEARN button**
Press to adjust this unit to receive the WorldSpace frequencies available in your region.
- ⑪ **PTY button**
Press to search for programs on a particular topic (WS band only).
- ⑫ **MULTI/LANG button**
Press to select a language in a multi-language simulcast or to search for a language currently being broadcast by a broadcaster (WS band only).
- ⑬ **BAND button**
Press repeatedly to select FM AUTO, FM (FM mono), MW, and SW.
- ⑭ **PHONES jack**
Connect headphones for private listening (the speakers turn off automatically).
- ⑮ **MEMORY/CANCEL button**
Press to memorize or cancel preset stations and broadcasters, and to enter password numbers.

Rear Panel

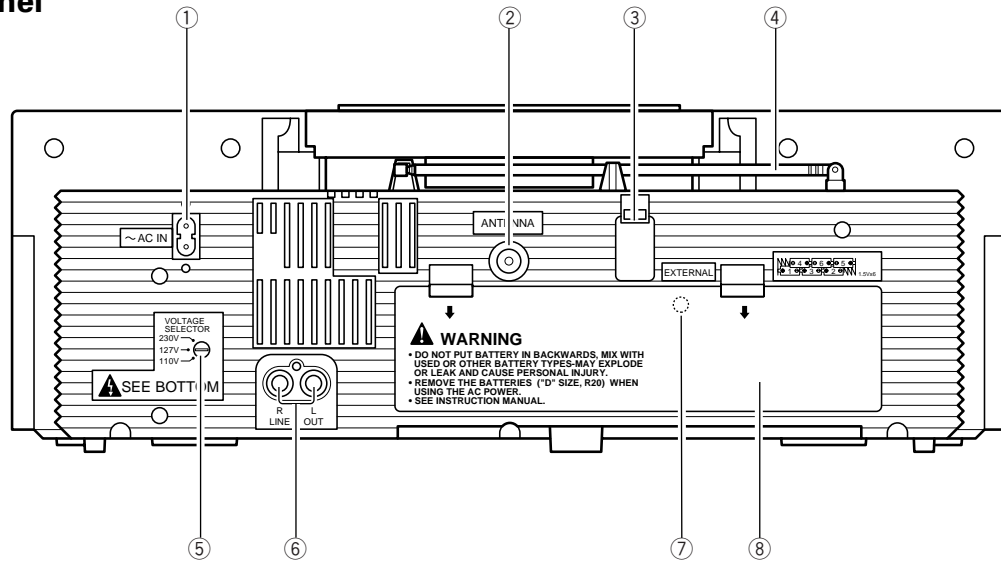

- | | |
|---|---|
| <p>① AC IN jack</p> <p>② WS antenna jack
Use to connect the WS antenna to this unit.</p> <p>③ EXTERNAL jack
For future use.</p> <p>④ FM telescopic antenna
Use to improve reception of FM radio stations.</p> <p>⑤ Voltage selector
Use to select the voltage setting appropriate for your region.</p> | <p>⑥ Audio line out jacks
Use to connect to an amplifier, tape deck or other device.</p> <p>⑦ (Manufacturer's use jack)
This jack is used in the production of this unit only. For proper use of this unit, DO NOT attempt to make any connections using this jack.</p> <p>⑧ Battery compartment cover</p> |
|---|---|

Display Panel

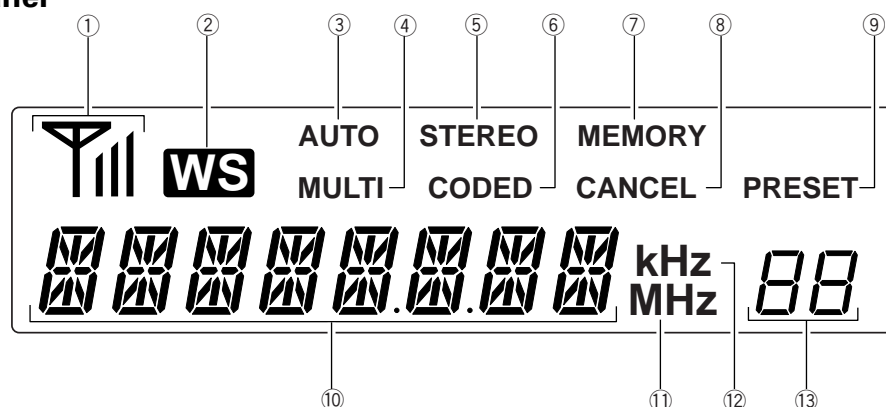

- ① **WS antenna reception indicator**
Displays the strength of the signal being received by the WS antenna.
- ② **WS indicator**
Indicates that the WS band mode is selected.
- ③ **AUTO**
Indicates that the FM AUTO mode is selected.
- ④ **MULTI**
Indicates that the WS broadcaster being received is simulcast in multiple languages or with multiple services.
- ⑤ **STEREO**
Indicates the reception of a stereo broadcast in both FM AUTO and WS band modes.
- ⑥ **CODED**
Indicates that the WS broadcaster is encoded using the WorldSpace Encryption Schemes 1 and 2 (ES1 and ES2).
- ⑦ **MEMORY**
Indicates that the preset MEMORY mode is active and that a selected preset can be assigned.
- ⑧ **CANCEL**
Indicates that the preset CANCEL mode is active and that a selected preset can be cancelled.
- ⑨ **PRESET**
Indicates that a preset number is being displayed beneath this indicator.
- ⑩ **Character display**
Displays information regarding system operations, radio frequencies, WS broadcaster identification (BCID), broadcaster Service Label (SL), broadcaster program number (PGM) and other functions.
- ⑪ **MHz**
Indicates that an FM or AM (SW) band frequency is being received.
- ⑫ **kHz**
Indicates that an AM (MW) band frequency is being received.
- ⑬ **Preset number display**
Displays the number of the currently selected preset.

Basic Operations

Setting up for WorldSpace reception

To initiate WorldSpace broadcaster reception

Before you can begin to receive broadcaster signals, it is necessary for this unit to establish what broadcaster range is available in your area. This operation is easily performed using the LEARN button.

- 1 Press the  button to turn this unit on.



- 2 Press the WS button to select the WS band.



- 3 Press the PRESET- /PRESET+ buttons to select the appropriate WorldSpace service area.

The region preset numbers appear in the display. The maps on page 18 contain the preset numbers for each area of coverage. Select the number most appropriate for the region that you live in.

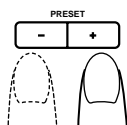

- 4 Adjust the WS antenna for optimum reception as described in "To adjust the WS antenna" on this page.

- 5 Press the LEARN button.

"LEARN?" appears in the display.

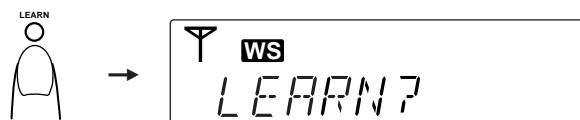

- 6 Press the LEARN button again while "LEARN?" is displayed.

"LEARN 99" appears in the display and begins counting down while the unit automatically searches for the WorldSpace broadcaster range available in your area. When the search is complete, "LEARN" disappears from the display. If the search was successful, sound is produced and the WorldSpace broadcaster range for your area is set in memory.

Notes:

- Pressing the WS button while the unit is searching ends the search and restores the unit to the previous operation mode.
- If the satellite signal reception in your area is too weak or for some reason reception is being blocked, the signals will not be received and "NO BEAM" appears in the display. Reposition or redirect the WS antenna to improve reception.

To adjust the WS antenna

For proper operation of this unit, do not proceed to other WS band operations until you have set up the WS antenna for satellite signal reception. Using the WorldSpace service area map and graphs on pages 18 and 19 as a guide, try to position the antenna in a line of sight with the satellite with as few obstructions as possible. Adjust the antenna by rotating and tilting to direct the WS antenna in the general direction of the satellite broadcasting to your region. The antenna can also be tilted up to 60° from the base.

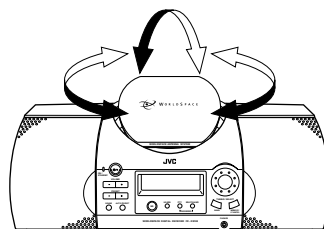

The WS antenna signal indicator in the display indicates the strength of the satellite signal being received. When the antenna icon appears alone, there is no signal being received. As the signal becomes stronger, bars appear to the right of the antenna icon. Try to adjust the antenna so that three bars appear for the strongest signal reception.

WS antenna signal indicator

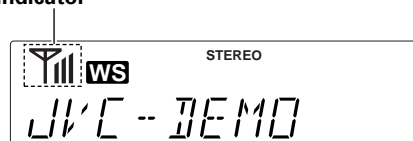

If necessary, detach the WS antenna from the mount as described on page 5, and attach the supplied extension cable in order to place the antenna in a location that provides better reception.

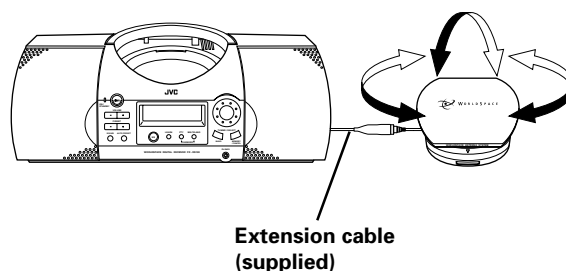

Extension cable (supplied)

Notes:

- When rotating the WS antenna, be sure to check that the antenna cable is not being pulled or stretched as that may cause the antenna to malfunction.
- As glass and tall structures inhibit the transmission of the signal, try to avoid directing the antenna toward windows or tall buildings.
- The signal indicator displays the reception of the overall satellite signal as opposed to actual broadcaster reception. Because of this, even when the strongest signal indicator is shown, the sound may be intermittent. This is not a malfunction.

Listening to WorldSpace broadcasters

1 Press the WS button to select the WS band.



2 Use the TUNING/SELECT dial to search for a broadcaster.

Turn clockwise for higher program numbers and counterclockwise for lower program numbers. During this operation, "BC UP" or "BC DOWN" appear in the display indicating the direction of the search.

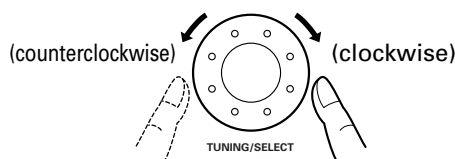

3 When the TUNING/SELECT dial is released, reception of the program at that location begins.

The broadcaster ID (BCID) of the currently selected broadcaster appears shortly in the display and is replaced by the Service Label of the broadcaster.

Broadcaster ID:

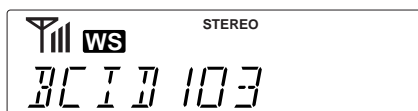

Service Label of the broadcaster:

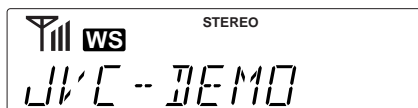

If the broadcaster has special features, the following indicators light in the display.

STEREO: The broadcaster you are listening to is in stereo.

MULTI: The broadcaster you are listening to is simulcast in multiple languages or with different services. For more information, refer to page 14.

CODED: The broadcaster is encoded, and cannot be listened to without a password. For more information, refer to page 16.

4 When the MULTI indicator lights, the broadcaster is transmitting multiple programs within the same BCID.

Press the LANG button to select the program (PGM) you want. By setting the User Preferred Language and the User Preferred Program Type, when a BCID with multiple programs is selected, the program with the selected language or program type is automatically tuned. For more information, refer to pages 14 and 15.

Notes:

- When selecting a broadcaster, the information from each broadcaster may take several seconds to receive. During this time, "WAIT" appears in the display.

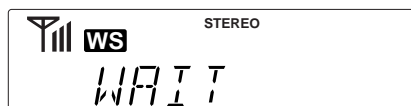

- Occasionally, a WS broadcaster may broadcast a single program during a certain time period and then broadcast simultaneous programs in different languages or with different content at other times. When this type of program change occurs, "CHANGING" appears in the display. During this time, if the TUNING/SELECT dial is turned, "WAIT" appears in the display. When "CHANGING" disappears, the TUNING/SELECT dial can be used to select another broadcaster. If "CHANGING" doesn't disappear from the display for some time, turn the unit off and then on again.



- Occasionally, a selected program may be transmitting non-audio information. When this occurs, "NO AUDIO" appears in the display alternately with the broadcaster's Service Label (SL).

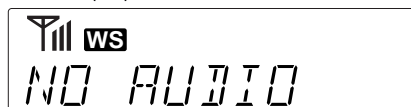

- Even if a broadcaster is available in the service area where you live, reception of the signal for that broadcaster may not be possible in all parts of the service area. This is not a malfunction.
- If the LEARN function has established that more than one frequency is available in your area, turning the TUNING/SELECT dial will switch to broadcasters on other available frequencies automatically.
- When selecting the WS band, be sure that the telescopic antenna is retracted and locked in its holding position. Having the telescopic antenna extended may interfere with WS antenna reception.

One button WS band operation

When this unit is in standby, pressing the WS button turns the power on, selects the WS band, and tunes in the last broadcaster received.

Listening to the radio (FM/AM (MW/SW))

1 Press the BAND button repeatedly to select a band.

You can select FM AUTO, FM (FM mono), MW, and SW. The selected band appears in the display ("FM" appears in the display for both FM AUTO and FM (FM mono) modes).

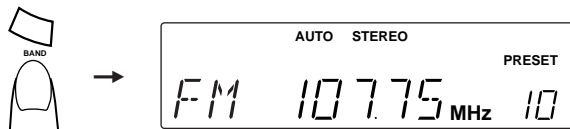

2 Use the TUNING/SELECT dial to tune to a station.

Turn clockwise for higher frequencies and counterclockwise for lower frequencies. The current frequency appears in the display. When the peak frequency is reached, the progression returns to the lowest band frequencies.

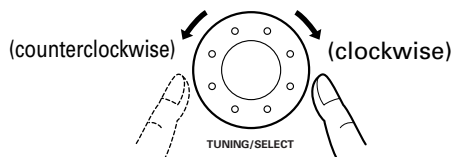

3 Release the TUNING/SELECT dial when the desired frequency has been reached.

The frequency is instantly received.

Notes on FM stereo reception

- Set this unit to FM AUTO to listen to an FM broadcast in stereo. The STEREO indicator lights in the display when an FM stereo broadcast is received.
- When FM stereo reception is intermittent, noisy, or when the signal is weak, pressing the BAND button to select FM (FM mono) may improve overall reception of the signal. If another station is tuned while in FM (FM mono) mode, this unit automatically switches to FM AUTO mode.

To change the MW channel space mode

When this unit is shipped, the channel space mode is set to MW-9 kHz (FM-50 kHz).

If the unit is to be used in North or South America, set it to MW-10 kHz (FM-100 kHz).

When switching to MW-10kHz

While pressing PRESET+, press the $\phi/1$ button to turn the unit on to switch to MW-10 kHz. "MW-STEP kHz 10" appears in the display. (This enables 10 kHz increment steps in MW frequencies and 100 kHz increment steps in FM frequencies.)

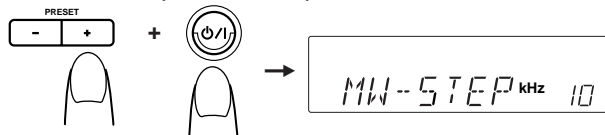

When switching to AM-9kHz

While pressing PRESET-, press the $\phi/1$ button to turn the unit on to switch to MW-9 kHz. "MW-STEP kHz 9" appears in the display. (This enables 9 kHz increment steps in MW frequencies and 50 kHz increment steps in FM frequencies.)

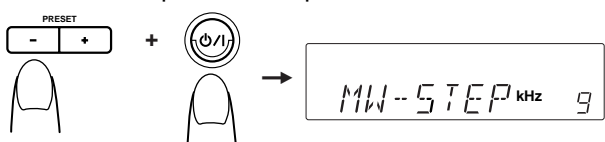

Improving radio reception

For FM and AM (higher frequency SW) stations, fully extend the telescopic antenna and adjust the direction of the antenna until the station you have tuned can be received clearly.

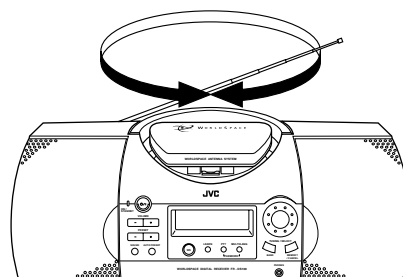

For AM (MW) and AM (lower frequency SW) stations, the antenna is located within the unit, so it is necessary to rotate the unit itself to obtain optimal reception.

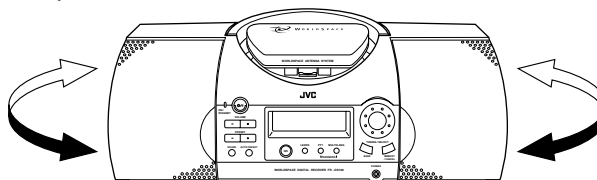

Note:

The built-in ferrite core antenna can pick up interference from television receivers in the area and thereby disturb AM (MW/SW) reception.

Changing the audio presentation of the broadcast

Use the SOUND button to adjust the quality or presentation of the sound of radio and WS BAND broadcasts. Press the SOUND button repeatedly to select one of the following effects.

BEAT: Enhances bass and drums for more dynamic music presentation.

POP: Enhances the frequencies common in pop music for better clarity in music presentation.

CLEAR: Filters the sound to remove unwanted noise from the broadcast. This mode is suitable when listening to the news or other spoken word programming.

FLAT: Broadcast is received without any effect added.



Presetting WS broadcasters and radio stations

20 stations in each radio band and 20 broadcasters in the WS band can be preset. Radio bands can be preset either automatically or manually. WS band broadcasters must be manually preset.

To preset stations automatically (radio bands only)

This function scans a selected band (AM (MW/SW), FM) and can automatically store up to 20 presets in memory for each band.

1 Press BAND to select the frequency band.

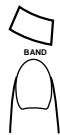

2 Press the AUTO PRESET button to enter the automatic memory mode.

The MEMORY and the PRESET indicators blink in the display. If no buttons are pressed for 5 seconds, the mode is exited.

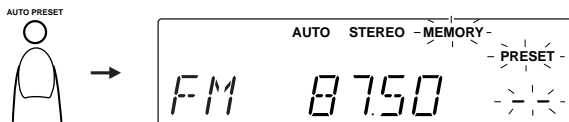

3 Press PRESET- / PRESET+ to select the preset number to begin memorizing presets at.

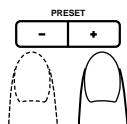

4 Press the AUTO PRESET button again.

The search begins automatically at the currently selected frequency.



5 When a broadcasting signal is found, the search pauses and the signal is received for 5 seconds.

At the end of this time, a preset for that frequency is memorized and the search continues for the next preset. However, if the AUTO PRESET button is pressed during this time, a preset is not memorized and the search continues to the next available frequency.

When the search is finished, the last preset frequency stored is tuned.

Notes:

- When the AUTO PRESET function is performed, presets previously stored will be replaced by the new presets.
- If the signal of a station is not strong enough, the search may not stop at that frequency when using the AUTO PRESET function. When this occurs, tune to the station manually and store the preset using the manual preset method shown on the next column.

To preset stations and WS broadcasters manually

This function is necessary to preset WS broadcasters or radio frequencies that require manual tuning to be received.

1 Select the station or WS broadcaster program to be preset.

2 Press MEMORY/CANCEL.

The MEMORY indicator lights in the display and the PRESET indicators blink.

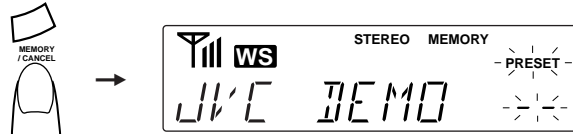

3 Press the PRESET- / PRESET+ buttons to select a preset location.

If neither button is pressed for 5 seconds, the MEMORY indicator disappears from the display and the mode is exited.

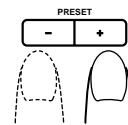

4 Press MEMORY/CANCEL again to memorize the preset.

The preset is stored in memory, and the mode is exited.



Clearing WS broadcaster presets

If you move from one WorldSpace service area to another, broadcasters that were previously preset may no longer be received. Follow the procedure described below to clear broadcaster preset information in the unit.

While the unit is on, press and hold the WS button and then the \odot/I button for 2 seconds until "INITIAL" appears in the display. All WS band broadcaster presets are cleared. Radio station presets are maintained in memory. Press the \odot/I button to turn the unit to standby and then on again to complete the procedure.

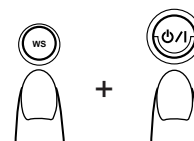

Preset Tuning

This function provides instant access to the preset frequencies or broadcasters stored in memory. However, it cannot be performed if you do not have any presets stored in memory. To preset stations, refer to "Presetting WS broadcasters and radio stations" on page 12.

1 Select the WS band or a radio band.

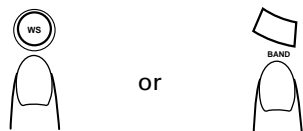

2 Press PRESET- or PRESET+ to select a stored preset.

When pressing PRESET+, if the maximum preset number is reached, the order starts over again at PRESET 1. Similarly, when pressing PRESET-, PRESET 1 continues in reverse order to PRESET 20.

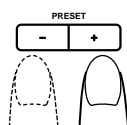

To cancel a preset

1 Select the preset to be cancelled.

2 Press and hold MEMORY/CANCEL for three seconds or more until the CANCEL indicator lights in the display and the PRESET indicators blink.

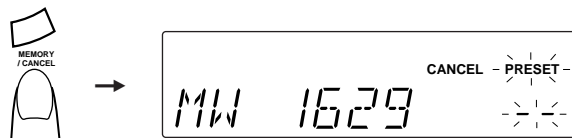

3 Use PRESET-/PRESET+ to select the preset to be cancelled.

If neither button is pressed for 5 seconds, the CANCEL indicator disappears from the display and the mode is exited.

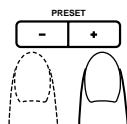

4 PRESS MEMORY/CANCEL again.

"CANCEL" appears in the display. The preset is cancelled, and the preset number is skipped during preset tuning.



AC power resume function

When using an AC power supply and the power supply is turned off during operation, if the power is turned on again within a period of up to 2 days, the unit is turned on and the last station received is instantly tuned. This function is convenient for making timed recordings of broadcasts using a commercially available audio timer.

Note

The AC power resume function does not work if the power is turned off by pulling the AC power cord out of the back of the unit.

Additional Operations

Searching for a preferred language

A single broadcaster is capable of broadcasting up to 8 different programs simultaneously. When multiple languages are broadcast, the MULTI indicator lights in the display and the MULTI/LANG button can be used to select the language. However, by setting the User Preferred Language (UPL), it is also possible for this unit to automatically select the program in the language you normally use.

To establish the UPL, it is first necessary to conduct a search for a program being broadcast in your language.

- 1 Press and hold the MULTI/LANG button for 3 seconds until "SEL-LANG" appears in the display.

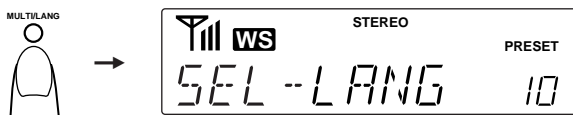

- 2 Turn the TUNING/SELECT dial to select one of the 20 languages in the menu. If the TUNING/SELECT dial position does not change for 5 seconds, the LANG search mode is exited.

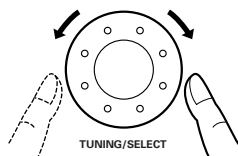

The languages that can be selected are as follows.

ENGLISH
SPANISH
ARABIC
PORTUG (Portuguese)
FRENCH
MANDARIN
HINDI
BAHASA
TAGALOG
SWAHILI
HAUSA
URDO
KOREAN
THAI
AFRIKAAN
CANTON
CATALAN
ITALIAN
PUNJABI
OTHER
NO LANG

- 3 Press the MULTI/LANG button again.

The unit searches for a program in the selected language. Reception of the program begins as soon as it is found. Press the MULTI/LANG button within 15 seconds of receiving a program to search for another program. If the MULTI/LANG button is not pushed again, the mode is exited and the current program will continue to be received.

Performing this search establishes the UPL. As many as three UPL can be stored in memory. When multiple language programming is encountered, the program in one of the established UPL will be automatically selected when available. UPL priority is based on the most recent language search performed.

Notes:

- To establish three languages as UPL, it is necessary to perform a language search for each language. Note that priority is given to the most recent language searched for.
- If the selected language is not found, "NO PGM" appears in the display and the unit returns to the previously received broadcaster.
- Language information is transmitted by the broadcaster. Therefore, though a program with the specified language is detected, the language of the actual program may be different. This is not a malfunction.
- Pressing the WS button during a language search ends the search and returns to the previously received broadcaster.

Searching for a program type (PTY)

With the WS band, you can use the PTY function to search the available broadcasters for the specific type of program you are interested in.

1 Press the PTY button.

"SEL-PTY" appears in the display.

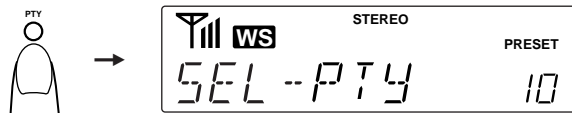

2 Turn the TUNING/SELECT dial to select one of the PTY menu items.

If the TUNING/SELECT dial position does not change for 5 seconds, the PTY mode is exited.

The program types that can be selected are as follows.

NEWS:	for programs carrying regional or global news.
INFO:	for programs on health, culture and community events
SPORT:	for programs featuring sports coverage of all types of sports
EDUCAT:	for educational programs
CHILDREN:	for educational and entertaining programs for children
TALK:	for talk shows, spoken word, issue-oriented shows, call-in shows, religious or comedy variety programs.
WORD ENT:	for storytelling, radio dramas and other spoken word entertainment .
CLASSIC:	for European classical music programs
SOUND T:	for programs featuring movie sound track music
JAZZ:	for jazz music programs
COUNTRY:	for country music programs
POP:	for contemporary popular music, both regional and global
ROCK:	for rock music programs
URBAN:	for R&B, soul, rap, and dance music programs
OTHER:	for alternative programs
NO PTY:	for no specific PTY

3 Press the PTY button again.

The selected program type blinks in the display and a search is performed.



4 When a program type is found, the broadcaster ID or the name of the broadcaster blinks in the display for 15 seconds. To search for another program, press the PTY button again at this time.

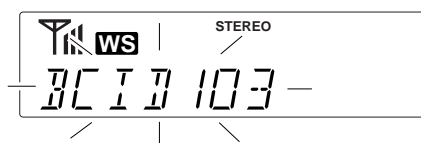

Performing a PTY search establishes the User Preferred Program Type (UPPY). Unlike the UPL, only one UPPY can be stored in memory. When the MULTI indicator lights indicating a broadcaster featuring different types of programs is selected, the program corresponding to the established UPPY is automatically selected.

Notes:

- If the selected program type is not found, "NO PGM" appears in the display and the unit returns to the previously received broadcaster.
- The program type information is transmitted by the different broadcasters. Therefore, though a program of the specified type is detected, the content of the actual program may be different. This is not a malfunction.
- Pressing the WS button during a PTY search ends the search and returns to the previously received broadcaster.

Regarding encrypted broadcaster signals

Some broadcasters are available by subscription only, or may not be available in certain areas, and the signals from these broadcasters are protected by the WorldSpace Encryption Schemes 1 and 2 (ES1 and ES2). When you try to receive these broadcasters, the broadcast is scrambled and the CODED indicator lights in the display. If a broadcaster carries a service you are interested in, the steps below describe the process necessary to decode the broadcast.

1 Contact a WorldSpace center or an authorized WorldSpace service provider regarding broadcaster services and rates in your region. Refer to page 21 for a list of WorldSpace centers worldwide.

2 Fill out the application form. At this time, the ID number of the unit is necessary. An ID number number sheet with 3 stickers is included with this unit. The ID number can also be found on the rear panel of this unit. On the receipt of the application and any necessary fees, you will receive a password corresponding to the ID number of your unit. The password may be as long as 22 digits in the following format: A12345-B67890...E12

3 Enter the password.
1. Press and hold the PTY and MULTI/LANG buttons for three seconds until "PWA_" appears in the display.

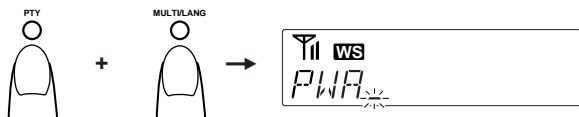

2. Turn the TUNING/SELECT dial to select the first number in the "A" password from 0-9 and then press the MEMORY button. Repeat this process for each number in the "A" sequence of the password.

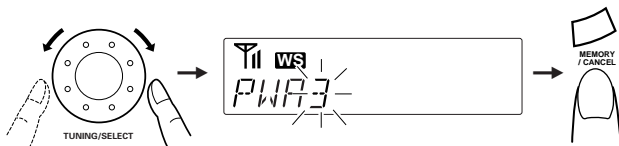

3. Continue the same process until the password has been completely entered. The unit checks if the password is correct. If the password was entered correctly, "COMPLETE" appears in the display. If the password was entered incorrectly or is invalid, "PW AGAIN" appears in the display, and the password must be entered again from the beginning.

Notes:

- If you make a mistake while entering the password, press the MEMORY/CANCEL button when the cursor is not selecting a number to move the cursor back to the previous number. Continue this procedure until the cursor has moved back to the incorrectly entered number. Numbers that you had entered after that number must be reentered.
- If you wish to reenter the password from the beginning, press the WS button and the password is erased and the mode is exited. Repeat the procedure on this page from step 3 to enter the password in again.
- If "COMPLETE" appears in the display, but you are still unable to listen to the broadcaster, contact your nearest WorldSpace center.
- When the password is entered, sound may be intermittent.
- Up to 4 passwords can be stored in memory. Be sure to keep your passwords in a safe location where they can be easily found in case they are somehow erased from memory.

Displaying the unit ID number

Press the PTY button, MULTI/LANG button and LEARN button at the same time for 3 seconds. "ID" appears in the display, followed by the first 8 numbers of the serial number, and then the last 8 numbers of the serial number. This pattern repeats three times and then returns to the previous display. Pressing any button ends this operation.

Recording a broadcast from the radio or WS band

This unit is supplied with stereo output jacks that allow you to make recordings of the programs you receive. You can also output the audio signal to an amplifier or similar component with line inputs.

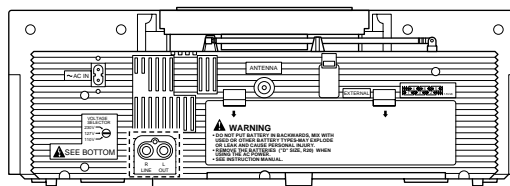

LINE OUT

To make connections, use a stereo cable to connect the output jacks on the FR-DS100 to the input jacks on the other component. Be sure to match the colors of the cable plugs with the color of the jacks; red with red, and white with white.

Tuning the Time Division Multiplex (TDM) frequencies manually

The L-band frequency range used for WorldSpace broadcasters is divided into a grid comprised of 82 blocks of 460 kHz segments. With this unit, it is possible to tune the individual grid positions and polarities manually.

If you are able to receive WS broadcasters, it is NOT necessary to perform this operation. However, there may be occasional changes in the transmitted signal which may require use of this function. Worldspace will inform you of any alteration in the frequency range available in your area.

1 When the power is on, press and hold the WS button for 3 seconds or more.

The currently received TDM grid number and polarity (L or R) appear in the display.

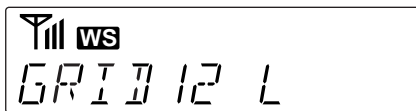

2 Use the rotary encoder dial to select the TDM frequency. Turn the rotary encoder dial clockwise for higher grid numbers, and counterclockwise for lower grid numbers.

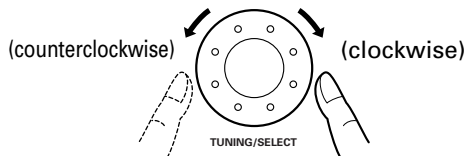

The order of the TDM frequencies changes in the display as follows. When the highest grid position (GRID 82R) is reached, the count will continue on from the lowest position (GRID 1 L) and similarly in the reverse direction.

... ↔ GRID12 L ↔ GRID12 R ↔ GRID13 L ↔ ...
 ... ↔ GRID82 R ↔ GRID 1 L ↔ ...

3 When the correct grid number and polarity is selected, broadcaster reception begins and normal operation returns.

The graph below shows the current grid positions and polarities corresponding to the area preset numbers shown in the maps on page 18.

Preset	Grid	Polarity	Frequency (MHz)
1	34	R	1468.564
2	39	L	1470.864
3	44	L	1473.164
4	49	R	1475.464
5	55	R	1478.224
6	60	L	1480.524
7	44	R	1473.164
8	49	L	1475.464
9	55	L	1478.224
10	60	R	1480.524
11	76	R	1487.884
12	81	L	1490.184
13	44	R	1473.164
14	49	L	1475.464
15	55	L	1478.224
16	60	R	1480.524
17	76	R	1487.884
18	81	L	1490.184
19	1	L	1453.384
20	82	R	1490.644

This data current as of May 1999. For more details, contact a WorldSpace service center.

Additional Information

WorldSpace™ Coverage Area

The diagrams on this page display the areas of the world that can receive WorldSpace broadcast transmissions. Refer to the data on this page and the following page when setting the unit up for WorldSpace broadcast reception.

To read the maps on this page

Each WorldSpace satellite is in geostationary orbit transmitting three beams which, when combined, provide coverage to the larger part of the continent it services. Each beam area, shown as oval shapes in the maps, contains preset numbers, shown as "Pn" within each oval area. These numbers are used when first setting up WorldSpace satellite reception on page 9. Be sure to use the region preset number for the region where you live. Incorrect preset number entry may cause the unit to operate incorrectly.

AFRISTAR™ Satellite

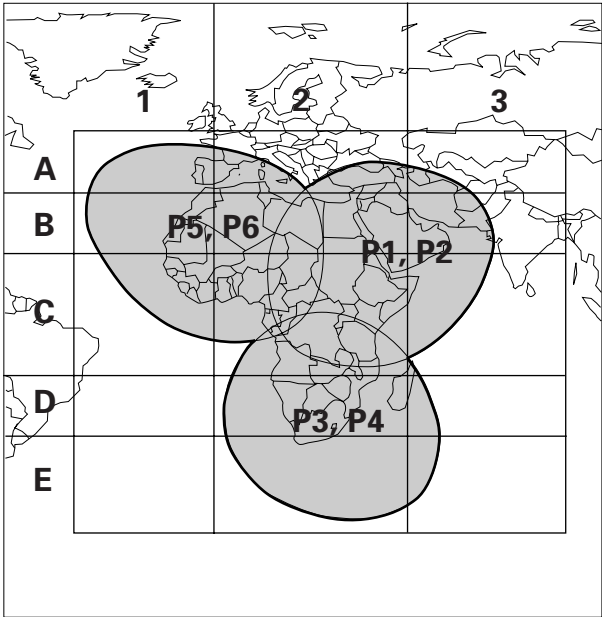

ASIASTAR™ Satellite

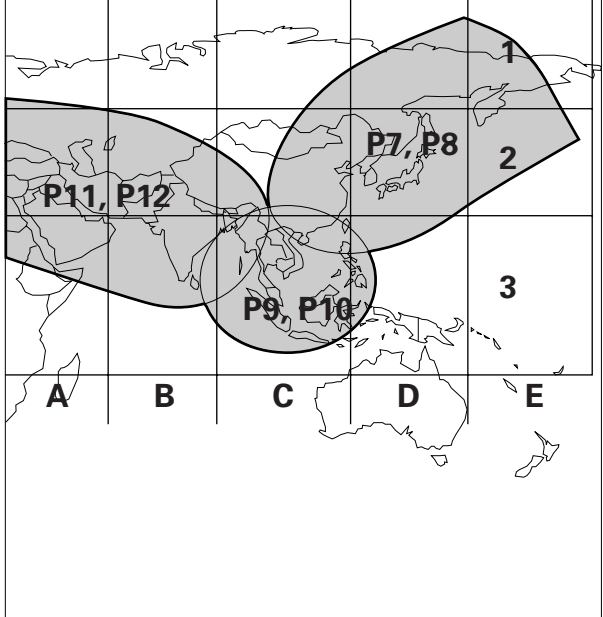

AMERISTAR™ Satellite

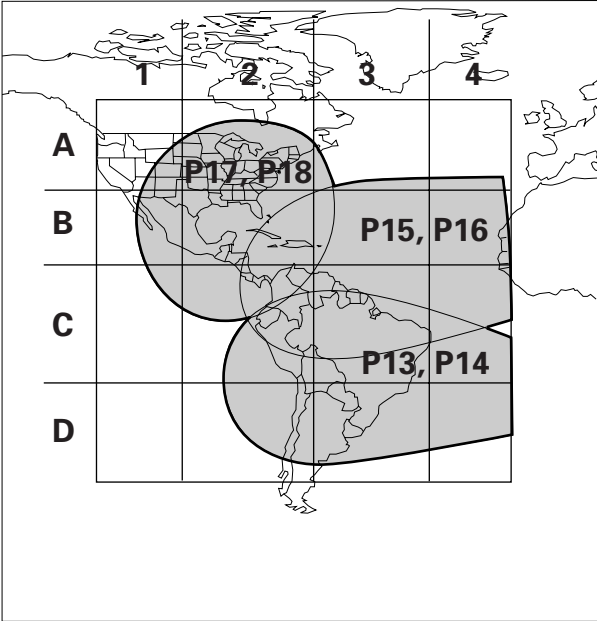

To read the graphs on this page

Proper positioning and placement of the WS antenna is essential to proper reception of the digital signal. Using the maps on the previous page, determine the two-character coordinates for the region where you live. With those coordinates, refer to the graphs below. The graphs indicate the ideal directionality and elevation of the WS antenna for optimal reception. Use this information combined with the signal indicator in the display to determine the best way to position your WS antenna. For more information on setting up the antenna, refer to page 9.

AFRISTAR™ Satellite

Area	Direction	Elevation
A-1	SOUTH-EAST	HIGH
A-2	SOUTH	HIGH
A-3	SOUTH-WEST	HIGH
B-1	SOUTH-EAST	MIDDLE
B-2	SOUTH	MIDDLE
B-3	SOUTH-WEST	MIDDLE
C-1	EAST	MIDDLE
C-2	FLAT	FLAT
C-3	WEST	MIDDLE
D-1	NORTH-EAST	MIDDLE
D-2	NORTH	MIDDLE
D-3	NORTH-WEST	MIDDLE
E-1	NORTH-EAST	HIGH
E-2	NORTH	HIGH
E-3	NORTH-WEST	HIGH

ASIASTAR™ Satellite

Area	Direction	Elevation
A-1	SOUTH-EAST	HIGH
A-2	SOUTH-EAST	HIGH
A-3	EAST	HIGH
B-1	SOUTH-EAST	HIGH
B-2	SOUTH-EAST	MIDDLE
B-3	EAST	MIDDLE
C-1	SOUTH	HIGH
C-2	SOUTH	MIDDLE
C-3	FLAT	FLAT
D-1	SOUTH-WEST	HIGH
D-2	SOUTH-WEST	MIDDLE
D-3	WEST	MIDDLE
E-1	SOUTH-WEST	HIGH
E-2	SOUTH-WEST	HIGH
E-3	WEST	HIGH

AMERISTAR™ Satellite

Area	Direction	Elevation
A-1	SOUTH-EAST	HIGH
A-2	SOUTH	HIGH
A-3	SOUTH-WEST	HIGH
A-4	SOUTH-WEST	HIGH
B-1	SOUTH-EAST	MIDDLE
B-2	SOUTH	MIDDLE
B-3	SOUTH-WEST	MIDDLE
B-4	SOUTH-WEST	HIGH
C-1	EAST	MIDDLE
C-2	FLAT	FLAT
C-3	WEST	MIDDLE
C-4	WEST	HIGH
D-1	NORTH-EAST	MIDDLE
D-2	NORTH	MIDDLE
D-3	NORTH-WEST	MIDDLE
D-4	NORTH-WEST	HIGH

The elevation of the WS antenna

The illustrations below correspond to the recommended elevation settings listed in the graphs on this page. Set the WS antenna accordingly.

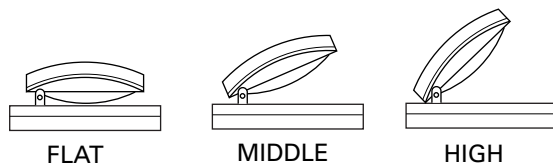

Troubleshooting

WorldSpace transmissions are not received.

- Check that the WS antenna is properly connected. If using the extension cable, make sure that all connections are correct and secure. Refer to page 5.
- Check that the WS antenna is positioned to receive satellite transmissions. Refer to page 9.
- Check that there are no obstructions blocking the path between the antenna and the satellite.

In the WS band, TUNER/SELECT is turned, but no broadcast is received.

- Make sure that the LEARN function has been performed to establish the broadcaster frequency available in your area. Even if the LEARN function was performed, but the antenna wasn't correctly oriented, no broadcaster frequencies will be stored in memory. Refer to page 9.

"BC GONE" appears in the display when you try to access a specific broadcaster.

- The broadcaster at that location has stopped broadcasting with the WorldSpace network.

The power cannot be turned on.

- Check that the power cable is firmly inserted into the AC IN jack on the back of the unit and also plugged into an AC outlet.

Though unlikely to occur, the unit "freezes up" or becomes unoperable during use.

- When using the AC power cord, unplug the power cord from the unit or from the wall outlet, then plug it again to restart the unit.
- When using batteries, remove the batteries, then load them again.
- When using batteries and the power cord is connected, unplug the power cord from the unit, then plug it in again and restart the unit.

There is no sound from the speakers.

- Check that headphones are not plugged in.
- Check that the volume is at an audible level.
- Check that the broadcaster you have selected is not encrypted (CODED lights in the display).

Radio reception is noisy.

Adjust the antenna appropriate for the band you are receiving to improve reception. Refer to page 11.

Specifications

WorldSpace

Transmitting frequencies	: 1453.384 MHz – 1490.644 MHz (L-Band 460 kHz step)
Broadcast system	: WorldSpace™ System
Digital modulation system	: QPSK-TDM
Audio coding system	: MPEG 1 / 2 / 2.5 Layer III
Encryption scheme	: ES1, ES2
Number of presets	: 20
Password memory	: 4

Antenna section

Polarization	: Left hand circular polarization (LHCP) Right hand circular polarization (RHCP)
Half power width	: > 60°
Power consumption	: 60 mW
Total gain	: 36.8 ± 2 dB (Element gain: > 6 dBi)
Reception system	: Double super heterodyne system
Minimum input sensitivity	: – 85 dBm
Maximum input sensitivity	: – 55 dBm

Tuner section

• FM	
Frequency range	: 87.5 MHz – 108.0 MHz
Frequency step	: 100 kHz 50 kHz
Number of presets	: 20
• MW	
Frequency range	: 530 kHz – 1600 kHz (10 kHz step) 531 kHz – 1602 kHz (9 kHz step)
(Except Saudi Arabian model)	: 530 kHz – 1710 kHz (10 kHz step) 531 kHz – 1710 kHz (9 kHz step)
Number of presets	: 20
• SW	
Frequency range	: 5.75 MHz – 17.95 MHz
Number of presets	: 20

General

Speaker	: 8 cm (3-15/16") x 2
Power output	: Max. 6.8 W (AC 230 V) (3.4 W + 3.4 W) at 4 Ω
Input jack	: WS antenna jack (F-type plug)
Output jack	: Headphones (MAX 20 mW/ 32 Ω) EXTERNAL (WS BAND) LINE OUT (Analog audio out)
Power supply	: AC 110/127/230 50/60 Hz DC 9 V ("R20/D (13F)" cell x 6)
Power consumption	: 12 W (with ⏻/⏻ (STANDBY/ ON) button ON) 1.6 W (with ⏻/⏻ (STANDBY/ ON) button STANDBY)
Dimensions	: 450 (W) mm x 158 (H) mm x 250 (D) mm (17 11/16 (W) x 6 1/4 (H) x 9 13/16 (D) in.)
Mass	: Approx. 4.6 kg (10 lb. 2 oz.) with batteries Approx. 4.0 kg (8 lb. 13 oz.) without batteries
Accessories provided	: WS antenna x 1 AC power cord x 1 8 m extension cable x 1 ID Number seals x 4 AC plug adapter x 1

Design and specifications are subject to change without notice.

WorldSpace™ Center Addresses

WorldSpace Corporate Services

WorldSpace Management Corporation
Am Weichselgarten 23
91058 Erlangen, Germany
Tel: 49 9131 6061 0
Fax: 49 9131 6061 99

WorldSpace Management Corporation
4 - 6 Soho Square
London, England W1V 5DE
Tel: 44 171 494 8200
Fax: 44 171 494 8201

WorldSpace - France
1, Impasse de Candie
31100 Toulouse, France
Tel: 33 5 61 43 82 82
Fax: 33 5 61 43 82 99

WorldSpace Management Corporation
Green House Building 2F
Nihonbashi-Tomisawacho
Chuo-ku, Tokyo 103-0006, Japan
Tel: 81 3 5643 8163
Fax: 81 3 5643 7254

WorldSpace Africa/Middle East

WorldSpace Ghana Ltd.
42 Independence Avenue
P.O. Box C838, Cantonments
Accra, Ghana
Tel: 233 21 22 6667
Fax: 233 21 23 8147

WorldSpace Southern Africa (Pty.) Ltd.
391 Jan Smuts Avenue
Craighall, 2196, Johannesburg, S.A.
P.O. Box 412466
Craighall, 2024, Johannesburg, S.A.
Tel: 27 11 789 9191
Fax: 27 11 886 6394

WorldSpace Ethiopia
W17, K23 Hse. No. 2173
P.O. Box 986
Addis Ababa, Ethiopia
Tel: 251 1 61 32 80
Fax: 251 1 61 32 99

AfriSpace (Kenya) Limited
16th Floor, Lonrho House
Standard Street
P.O. Box 43305
Nairobi, Kenya
Tel: 254 2 210805
Fax: 254 2 210845

WorldSpace Asia

AsiaSpace Ltd.
Level 4, 6 Riverside Quay
South Bank, Melbourne
Victoria 3006, Australia
Tel: 61 3 9693 8555
Fax: 61 3 9693 8585

WorldSpace Management Corporation
WISMA 46, Kota Bni
34th Fl. Jalan Jend
Sudirman Kav. 1
Jakarta 10220
Indonesia
Tel: 62 21 574 7513
Fax: 62 21 574 7514

WorldSpace Management Corporation
Regus Office 6
C203 Beijing Lufthansa Centre Offices
No. 50 Liangmaqiao Road
Chaoyang District
Beijing 100016 PRC
Tel: 8610 6465 1248
Tel: 8610 6465 1326
Fax: 8610 6465 1240

WorldSpace India
9th Floor, Shankarnarayana Towers
25/2, M.G. Road
Bangalore 560 001
India
Tel: 91 80 559 5183
Fax: 91 80 559 5181

WorldSpace Americas

WorldSpace Americas - Miami
815 NW 57th Avenue, Suite 441
Miami, FL 33126 USA
Tel: 305 265 0750
Fax: 305 265 0790

WorldSpace Caribbean
1-A Dere Street, Suite 5
Port of Spain
Trinidad & Tobago
Tel: 868 624 0172
Fax: 868 624 0202

Creative Services
Regional Office
Reference Guide

WorldSpace Entity
Technology Brochure 150
11/13/97



JVC
VICTOR COMPANY OF JAPAN, LIMITED